

VIVO SYSTEMS
ABITI CLOTHES SUPERLIFT

ABITI
SUPERLIFT
151A

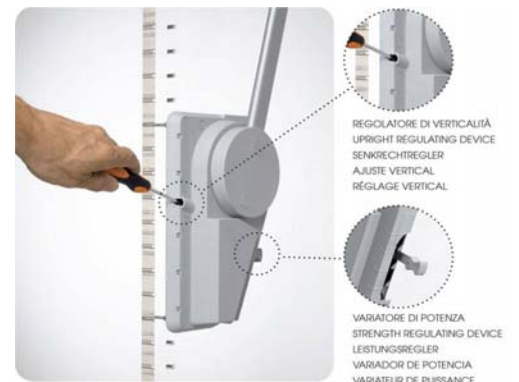

- Adjustable arm verticality
- Steel Mechanism
- Can be wall - mounted
- Hydraulic device (not oil operated)
- Max Capacity :**
20Kg (Adjustable from 14 to 20 Kg)
- Width :**
Minimum 750 mm - maximum 1150 mm
- Materials and Finishes**
- Plastic Parts :**
Nylon reinforced with grey fiberglass
- Matal Parts :**
Steel painted aluminium grey
Chrome plated horizontal bar



VIVO SYSTEMS
ABITI CLOTHES LIFT

ABITI
CLOTHES
LIFT 500



Max: 10 Kg

Made of Polyamid resin
and epoxy enamelled
steel



SPACERS



EXTRACTIBLE HANGER

VIVO SYSTEMS
ABITI CLOTHES LIFT

ABITI
CLOTHES
LIFT 700

Max Capacity :

15 kg

Width :

Minimum 750 mm - maximum 1150 mm

Materials and Finishes

Plastic Parts :

Nylon reinforced with grey fiberglass

Matal Parts :

Steel painted aluminium grey

Chrome plated steel horizontal bar

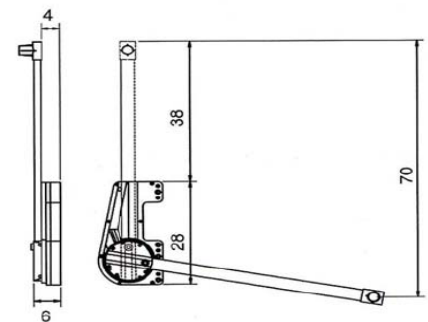
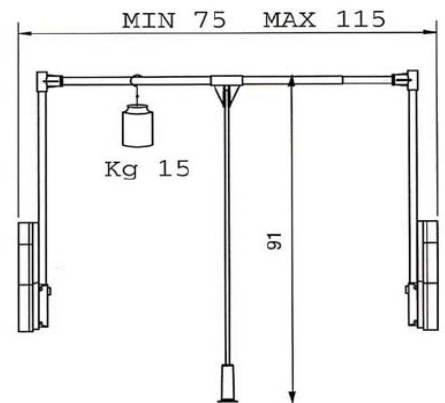

Shaped to avoid hinges





Material

End Caps and supports in Zinc with lacquer
Rod in aluminium with rubber insert for anti scratch

Features

- Top Mounted on Shelves
- Customized Lengths
- Option with Mid support
- Sleek Design

Application Mood

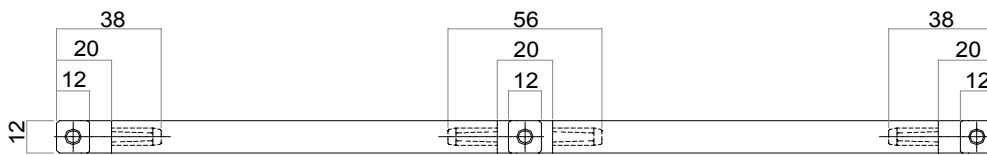

Plan

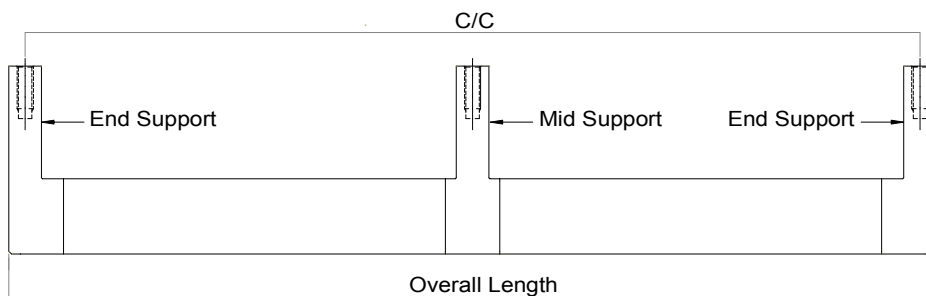

Elevation

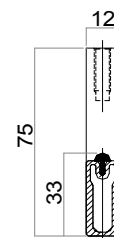

Rod Section

CODE	DESCRIPTION Clothes Hanging Rod in Anodised Aluminium	OVERALL LENGTH	C/C
200050	With End Supports Only	500mm	488mm
200060	With End Supports Only	600mm	588mm
200070	With End Supports Only	700mm	688mm
200085	With End Supports Only	850mm	838mm
200095	With End Supports Only	950mm	938mm
200115	With End and Mid Supports	1150mm	1138mm
200135	With End and Mid Supports	1350mm	1338mm

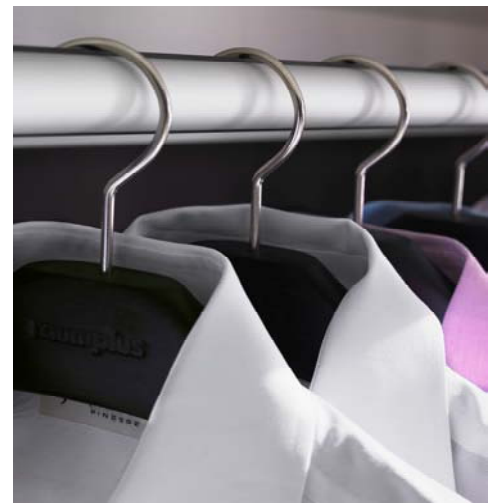

Application Mood

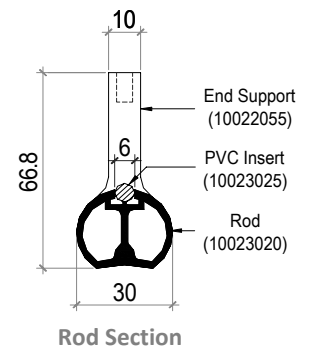
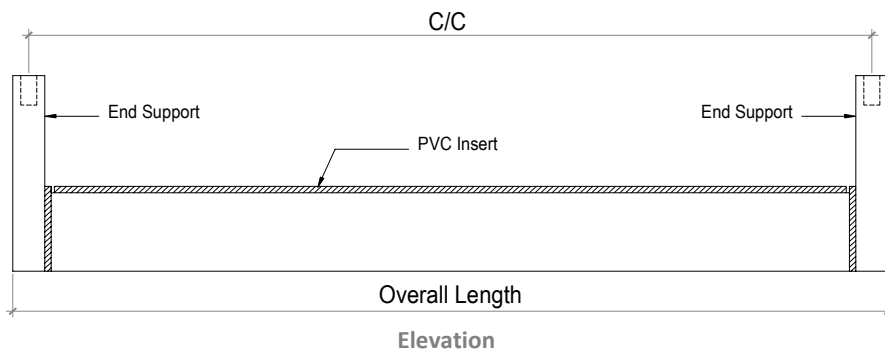

CODE	DESCRIPTION	OVERALL LENGTH	C/C
	Clothes Hanging Rod in Anodised Aluminium		
100500	With End Supports	500mm	490mm
100600	With End Supports	600mm	590mm
100700	With End Supports	700mm	690mm
100850	With End Supports	850mm	840mm
100950	With End Supports	950mm	940mm
101150	With End Supports	1150mm	1140mm
101350	With End Supports	1350mm	1340mm

DRESSY Hanging Rod

Hanging rods in anodised aluminium



CLOTHES ROD

DRESSY

Materials:

Hanging Rods in matt anodised aluminium
 Support Brackets for TOP and SIDE mounting
 Intermediate support for long spans

Country of Origin

Italy

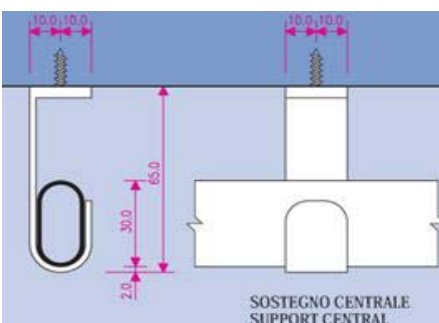
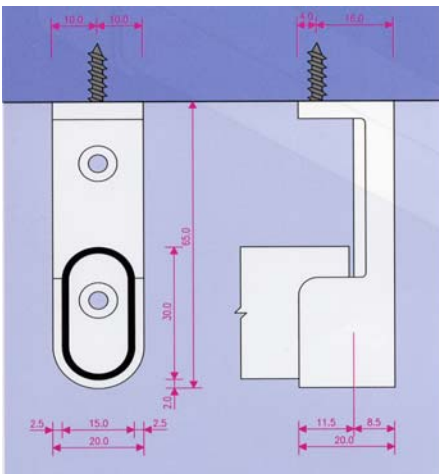
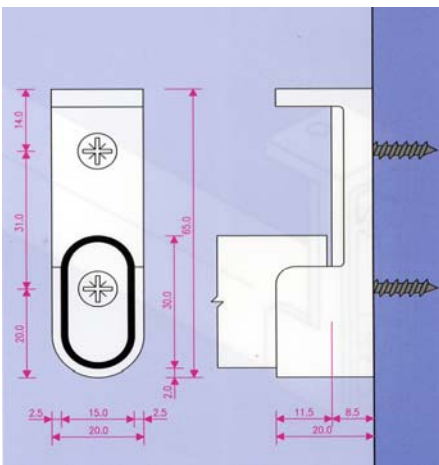
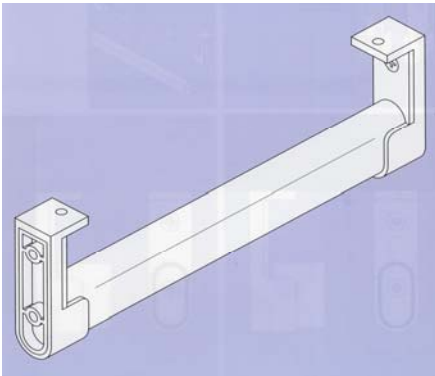

3000 mm	471319
478710	
478705	
478716	



Material

End Caps and supports in Zinc with lacquer
Rod in aluminium with rubber insert for anti scratch

Features

- Top Mounted on Shelves
- Customized Lengths
- Option with Mid support
- Sleek Design

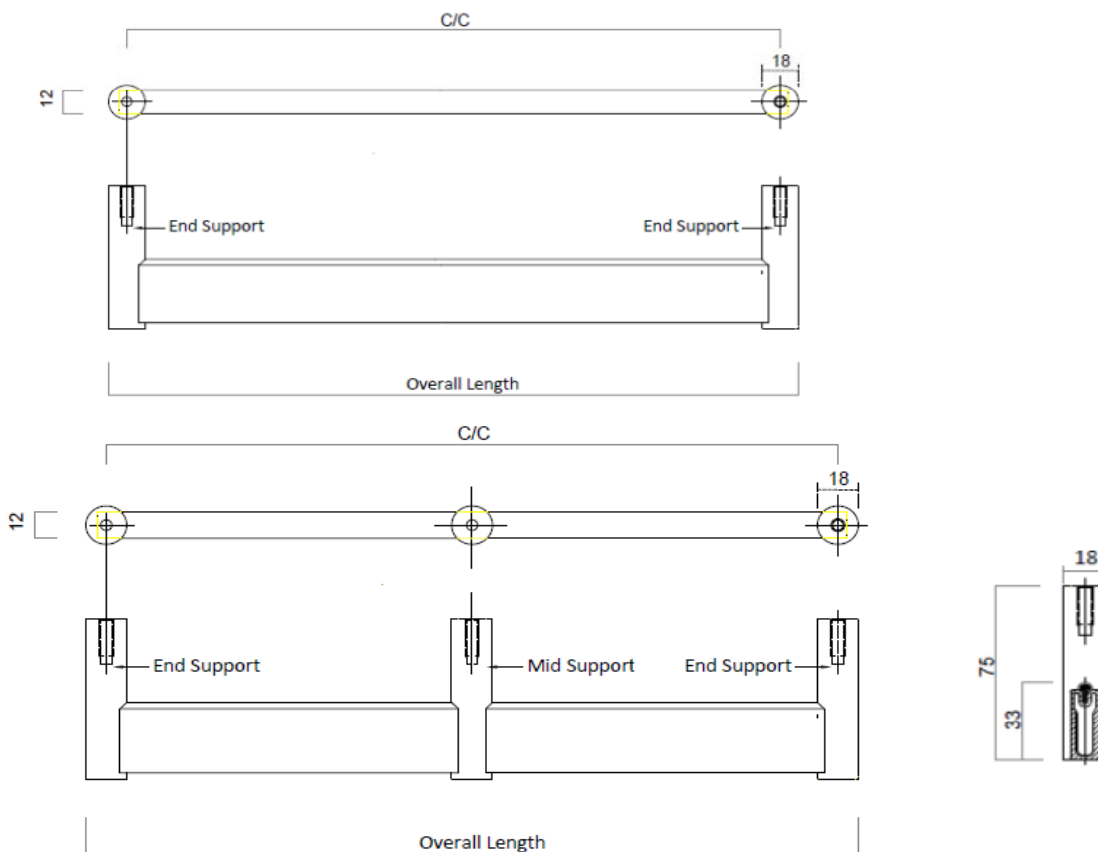

CODE	DESCRIPTION	OVERALL LENGTH	C/C
201060	With End Supports Only	600mm	581mm
201075	With End Supports Only	700mm	681mm
201095	With End Supports Only	950mm	931mm
201115	With End and Mid Supports	1150mm	1131mm
201135	With End and Mid Supports	1350mm	1331mm
201150	With End and Mid Supports	1500mm	1481mm
201200	With End and Mid Supports	2000mm	1981mm

Material

End Caps and supports in Zinc with lacquer
Rod in aluminium with rubber insert for anti scratch

Features

Top Mounted on Shelves

Designer

GIUSEPPE BAVUSO
Patented Design

MADE IN ITALY



Application Mood

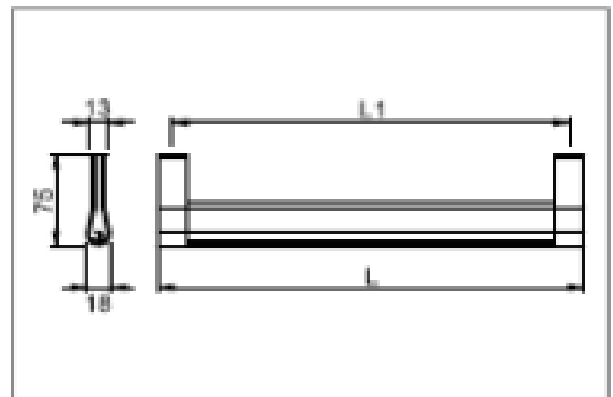
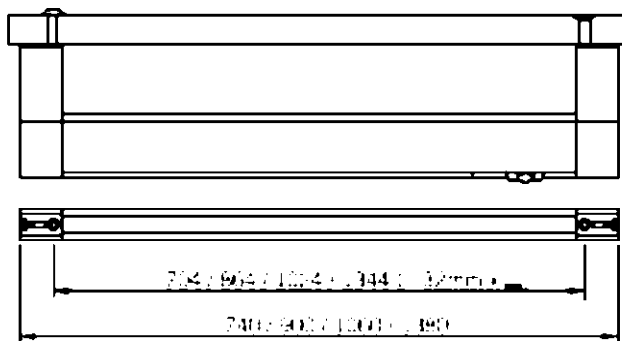

CODE	DESCRIPTION Clothes Hanging Rod in Anodised Aluminium	OVERALL LENGTH (L)	C/C (L1)
541074	Aluminium Hanging Rods with anti scratch Strip	740	704
541090	Aluminium Hanging Rods with anti scratch Strip	900	864
541106	Aluminium Hanging Rods with anti scratch Strip	1060	1024
541138	Aluminium Hanging Rods with anti scratch Strip	1380	1346
Other lengths	Available upon requests		



Application Mood

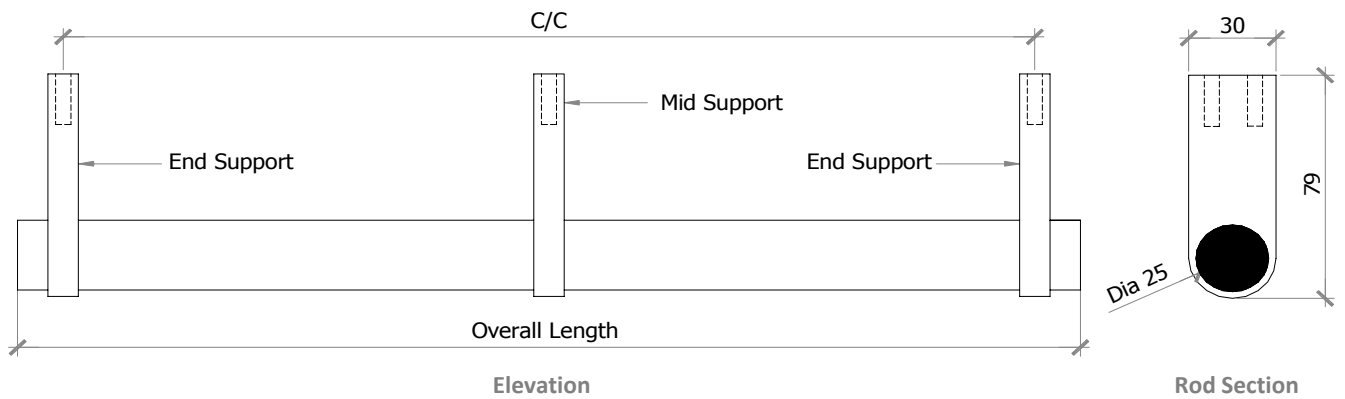

CODE	DESCRIPTION	OVERALL LENGTH	C/C
	Clothes Hanging Rod in Anodised Aluminium		
460450	With End Supports Only	450mm	420mm
460500	With End Supports Only	500mm	470mm
460550	With End Supports Only	550mm	520mm
460600	With End Supports Only	600mm	570mm
460750	With End Supports Only	750mm	720mm
460850	With End Supports Only	850mm	820mm
460950	With End Supports Only	950mm	920mm
461150	With End Supports Only	1150mm	1120mm
461350	With End and Mid Supports	1350mm	1320mm
461450	With End and Mid Supports	1450mm	1420mm



Material
 End Caps in Zinc with lacquer
 Rod in Extruded aluminium
 TRANSPARENT insert for anti scratch

Features
 Top Mounted on Shelves
 Customized Lengths
 Sleek Design

MADE IN ITALY
 Design by: Riva Roberto

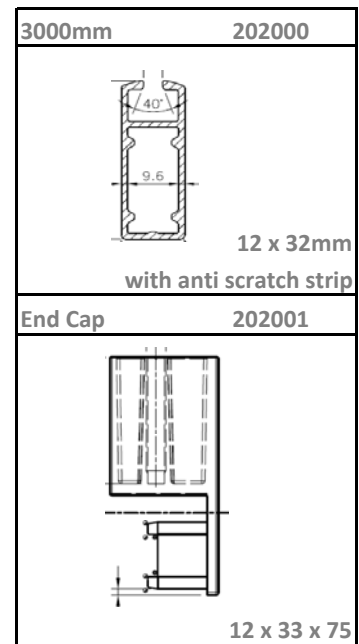

CODE	OVERALL LENGTH mm	C/C
202060	600	562
202075	750	712
202095	950	912
202115	1150	1112
202135	1350	1312

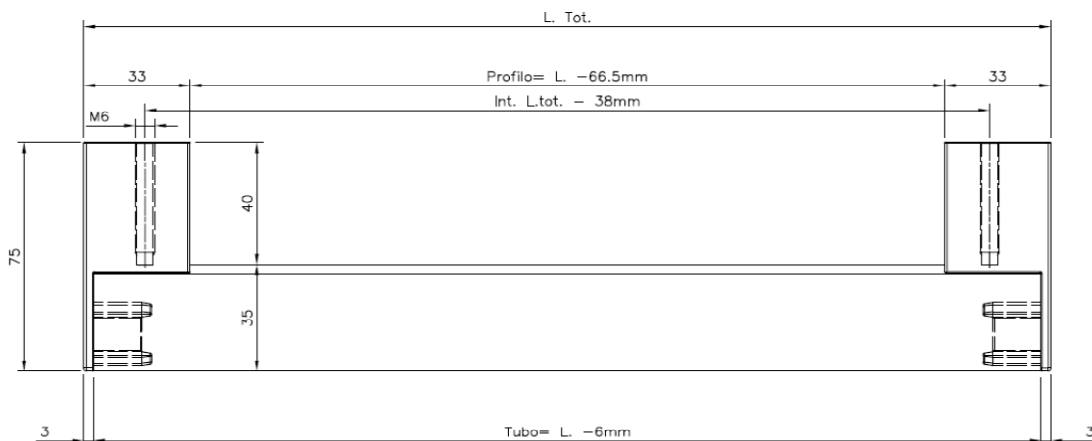

SETA Hanging Rod

Hanging rods in anodised aluminium

CLOTHES ROD

SETA

Materials:

Hanging Rods in matt anodised aluminium
 Support Brackets for TOP and SIDE mounting
 Intermediate support for long spans

Country of Origin

Italy



4000mm	472200
Sides	473001
Central	473003
Corner	473004

Materials:

Hanging Rods in matt anodised aluminium
Support Brackets for TOP and SIDE mounting

Country of Origin

Italy



4000mm	472200
4000mm	472100
	473006
	473005

Features

- Matt Aluminium Sides
- Drawer Front Profile in Aluminium to receive Glass
- Partial / Full Extension Runners with Option for Soft Closing
- Drawer Base not included in wood panel of your choice

Applications

WARDROBE DRAWERS



Application Mood



Application Mood

Code	Description
437767	Glass Front Holder
437766/76	Aluminium Drawer Sides

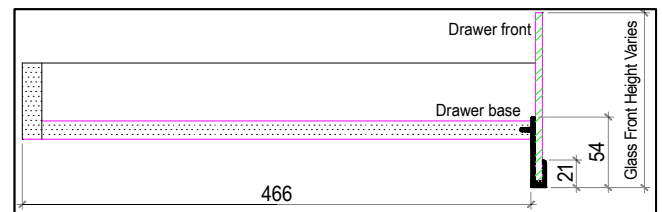

Drawer Side

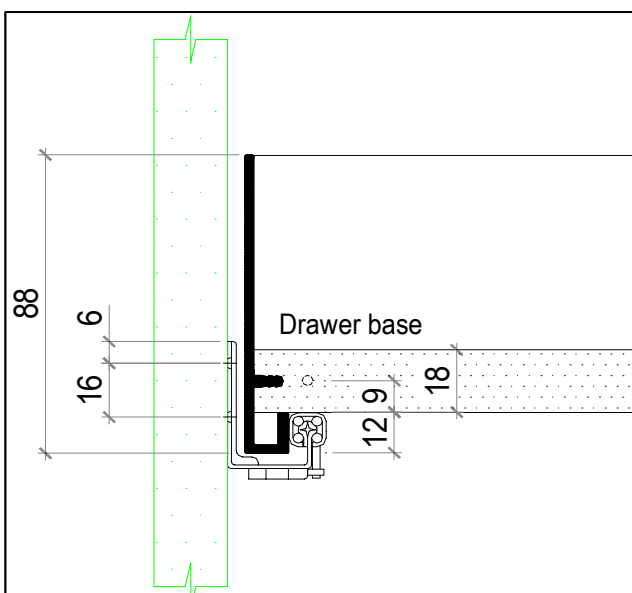

Drawer Side Details

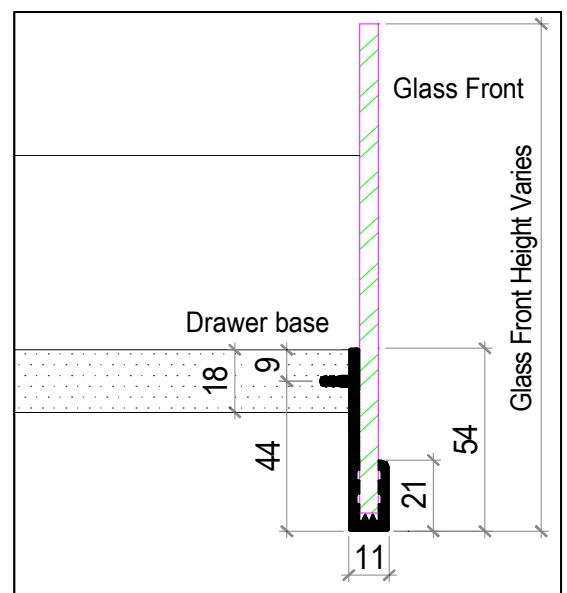

Drawer Front Details

Applications

For shirts and folded clothes
For Handbags, belts accessories etc

Material

Anodised aluminium frames
and base in studded aluminium
Partial or full extension concealed runners

Country of Origin

ITALY

Sizes on Available

Code	Width (A) mm	Depth mm
438587	587	470
438593	593	470
438667	667	470
438787	787	470

Custom Sizes On Order

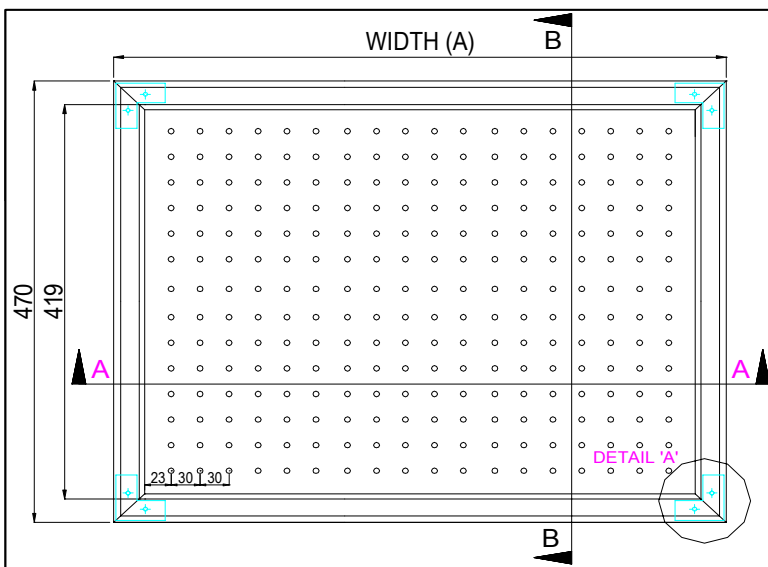
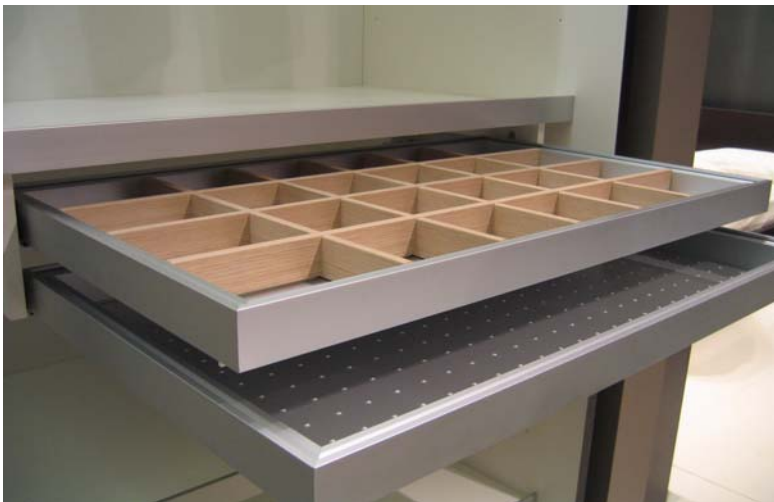

PLAN

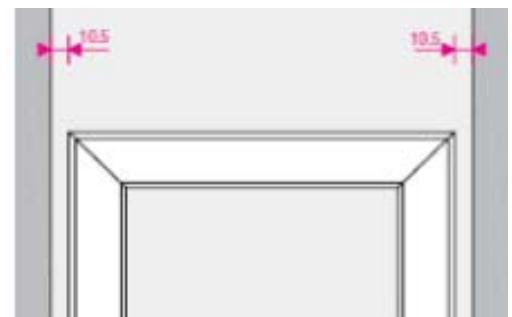

Width of tray = Carcass Internal - 21mm

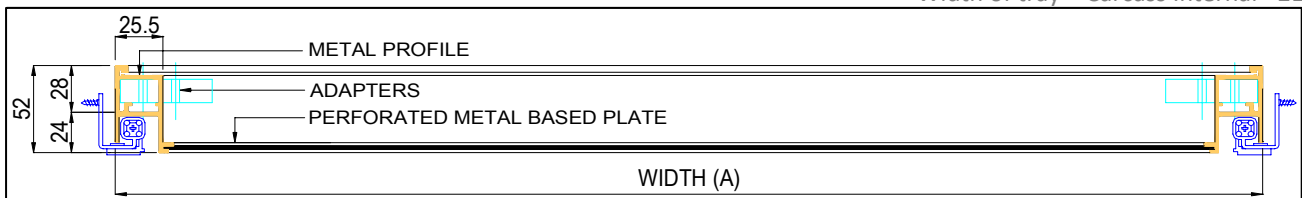

SECTION A-A

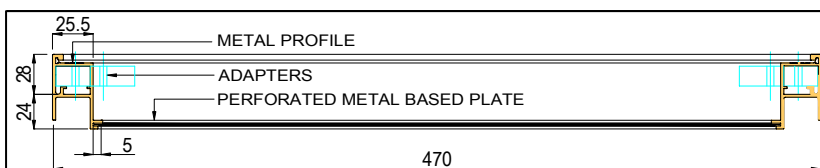

SECTION B-B

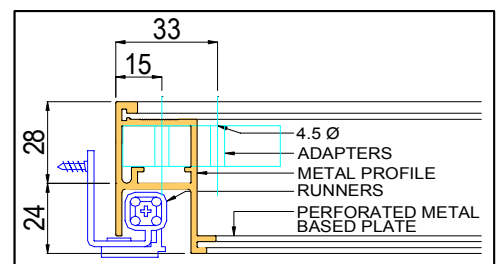

ZEN TROUSER RACK

Slide out Trousler Rack completely in aluminium with full extension runners

ZEN

TROUSER TRAY

Features

For Trousers, ties etc

Material

Anodised aluminium frames
Aluminium rods with anti slip gasket
Full extension concealed runners

Country of Origin

Made in Italy

Ex-Stock

Code	Width mm	Depth mm
439489G	489	470
439545G	545	470
439787G	787	470

Custom sizes on request



Application Mood

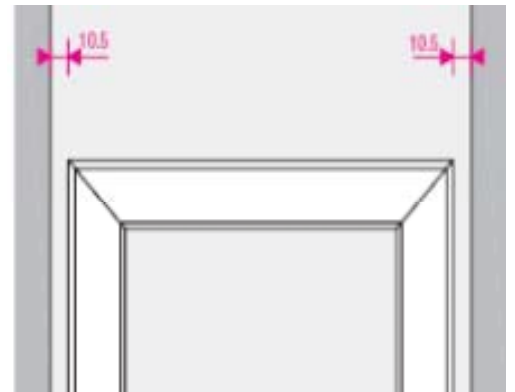
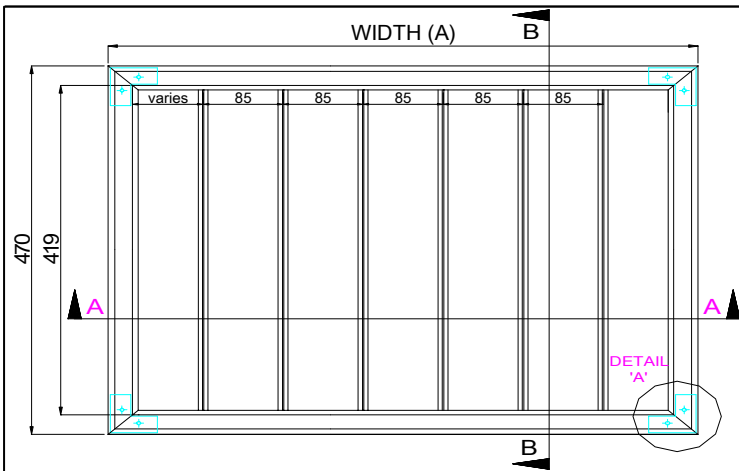

Width of tray = Carcass Internal - 21mm

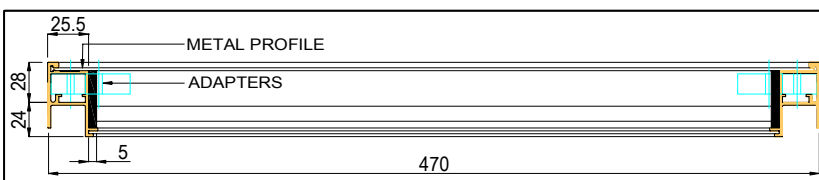

SECTION B-B

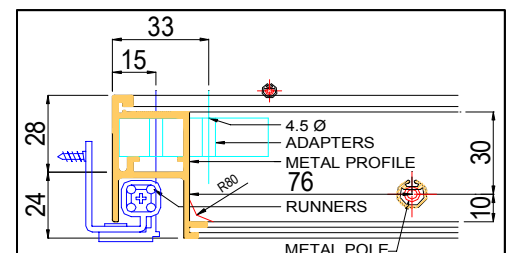

DETAILS 'A'

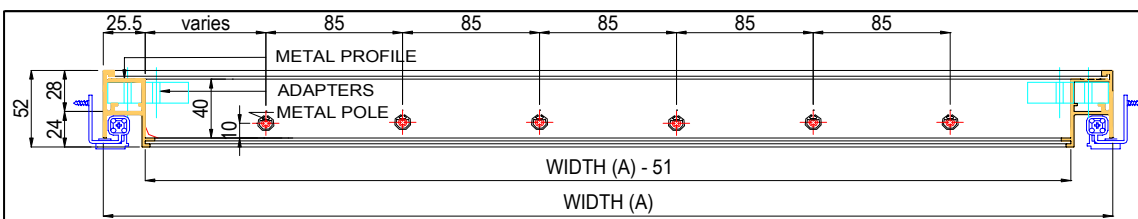

SECTION A-A

EXTRACTABLE TROUSERS HOLDER

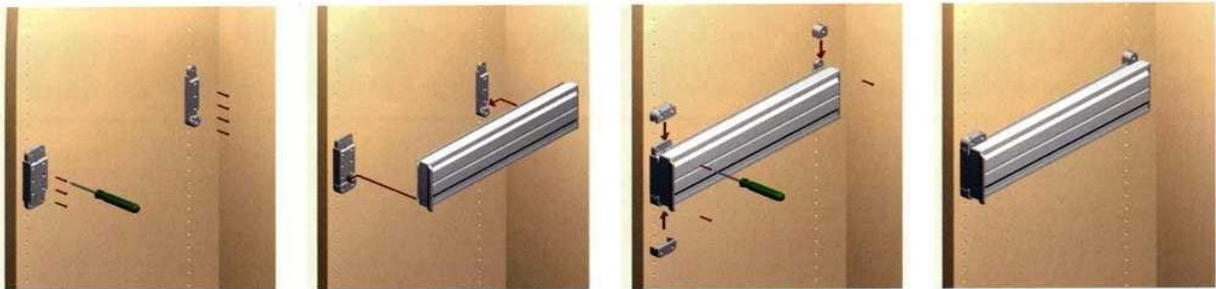
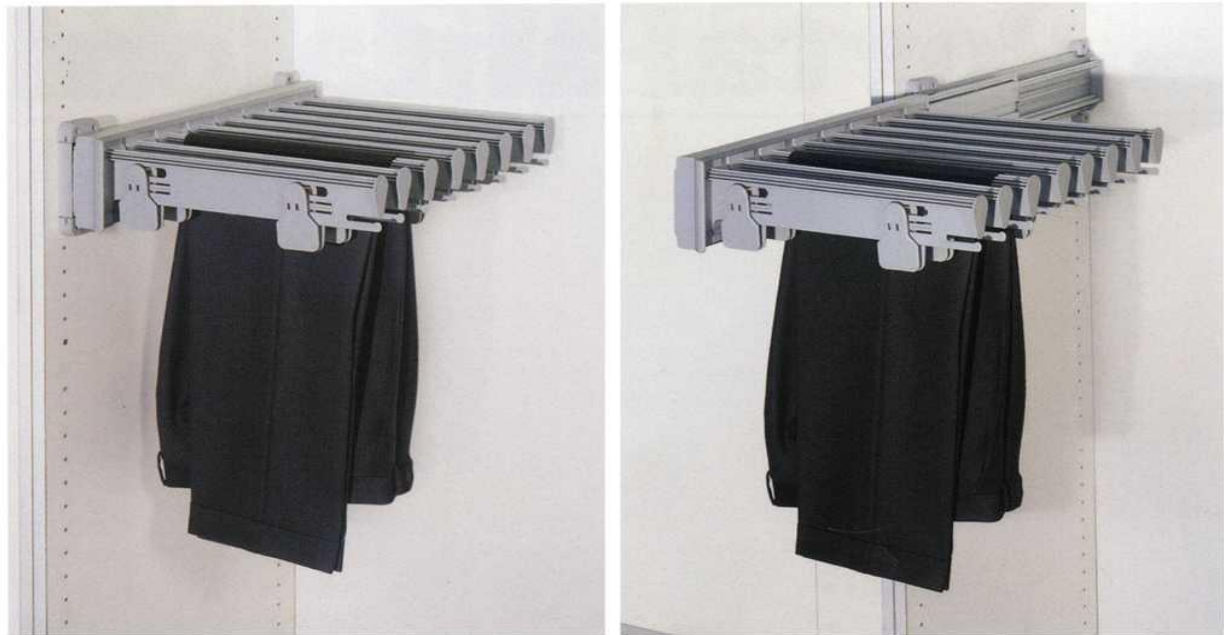

Trouser holder, completely extractable, on anodised aluminium guides sliding on balls.

Its fixing on one side only (either right-hand or left-hand) does not bind it to the wardrobe width.

Each trouser holder is equipped with 8 trouser supports provided with tongs to hold skirts and trousers both hanging or folded.



TECHNICAL DATA:

Capacity: 16 pairs of trousers

Maximum load: kg. 8

Material and finishing: plastic parts in polyamide resin in light grey colour reinforced with fibreglass, profiles in anodised aluminium silver colour.

Applications:

directly into the "system 32" line of holes with screws included in the package.

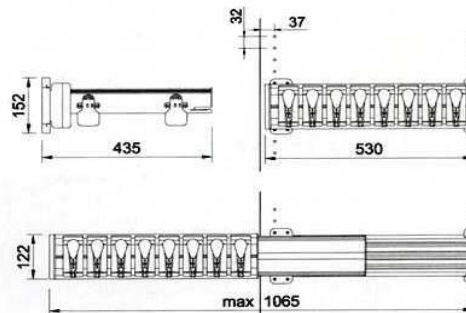

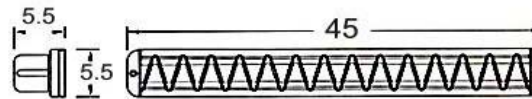

Fixed Tie/Belt/Foulard Rack - 27 places

Single aluminium profile. It can be fitted either inside the wardrobe or to its door (or even directly to the wall).

Length: 45cm

141 B	Black
141 A	Alu



Extractable Tie/Belt/Foulard Rack With Small Vessel - 19 Places including a transparent bowl for the small objects kept in your pockets.

The double aluminium profile allows the ties pull out from the wardrobe.

The fixing supports fit to the standard "System 32" perforation, the rear support slides to allow the positioning on boring having different depth.

The transparent plastic bowl is fixed to the sliding profiles.

Length: min 51 cm (closed)
max 92 cm (extended)

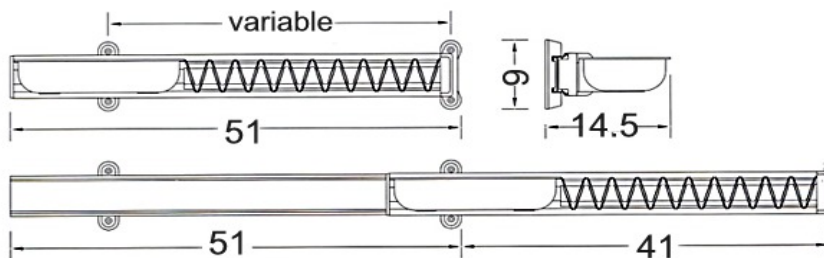

142 B	Black
142 A	Alu

VIVO SYSTEMS
SCARPE SHOE RACK

SCARPE
SHOE
RACK



Applications

Shoe Rack System

Option with or without Rails

Material

Aluminium Mounting Guides 1120 mm

Made in Italy

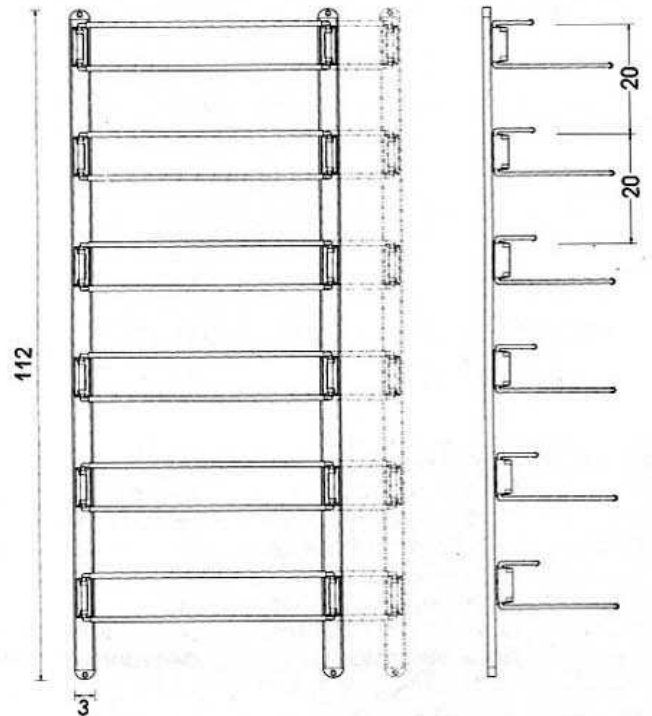
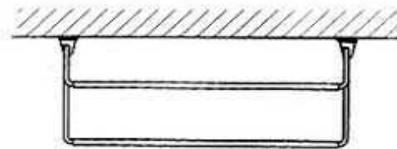
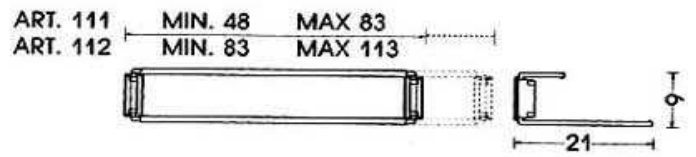

CODE	Width adjustable	Set
900111	480 - 830	6 shelves
900112	830 - 1130	6 shelves
900117	Upright 1120	1 pair

22-Jan-15